

MERAKI LED MODULES

ECO 282 - FOODY LINEAL CC

(280X24MM)

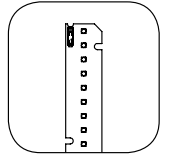

FOR
FRESH
FOOD!

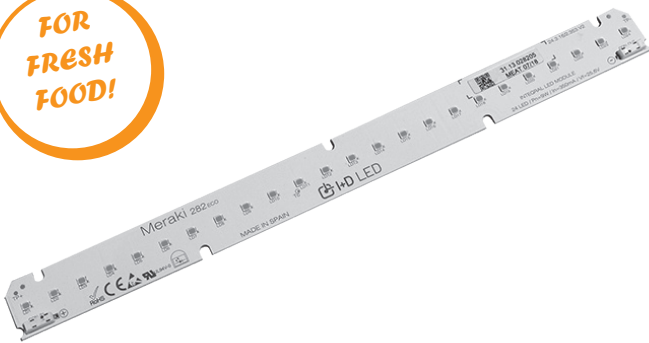

MERAKI family introduces FOODY line, a series of LED modules with optimized spectrum, a suitable fit for illumination of fresh groceries as bread, fish, vegetables, red meat and marbled meat. These modules are specially indicated for direct linear or area applications. FOODY modules hold an excellent lm/\$ relation and standard LED driver current. Efficiencies are determined by the chosen operating current. The modules have two different functioning: high flux and high efficiency. Depending on its input current, heatsinks could be avoided.



In compliance with:

IEC 62031 / IEC 62471 / IEC 62717

APPLICATION



PRODUCT DESCRIPTION

- Efficiency > 110lm/W
- Easy to install
- Push-In connectors
- Colour tolerance - 3 SDCM over CCT
- Available to illuminate meat, fish, bread and vegetables.
- Compact design
- SELV voltage
- High lm/\$ relation
- 5 years guarantee

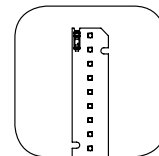

TECHNICAL DATA

- SELV voltage
- Available for MEAT - BREAD - FISH - VEGETABLES
- CRI80-90
- Operating temperature between -20°C and +45°C
- EN 61471:2008 group 1
- Standard Tc 65°C
- LED viewing angle 120°
- Weight 20 g
- MOQ 44 units
- Packaging box weight (approx.) 900 gr
- PWM dimmable

DIMENSIONS

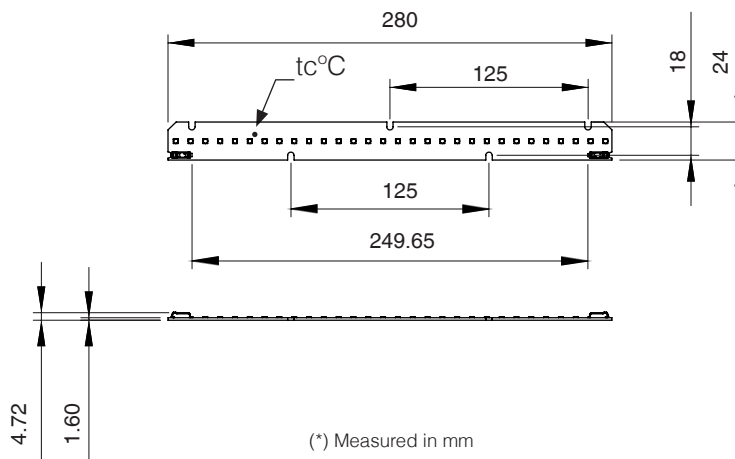

SPECIFIC TECHNICAL DATA

SPECIFIC TECHNICAL DATA

CODE	CCT	RATED CURRENT mA	VOLTAGE Min (V)	VOLTAGE Typ(V)	VOLTAGE Max(V)	NOMINAL POWER (W)	LUMINOUS EFFICACY (lm/W)	TOTAL FLUX (lm)(*)	PHOTO METRIC CODE
31.13.070201	BREAD	200	23,3	23,4	25,2	4,73	107,74	509,3	X
31.13.070201	BREAD	350	23,2	23,4	25,2	8,28	97,20	805,2	X
31.13.070201	BREAD	500	23,2	23,4	25,2	11,75	103,22	1212,5	X
31.13.070203	FISH	200	23,2	23,4	25,2	4,73	113,23	535,2	X
31.13.070203	FISH	350	23,2	23,4	25,2	8,28	116,18	962,4	X
31.13.070203	FISH	500	23,2	23,4	25,2	11,75	109,67	1288,3	X
31.13.070305	MEAT	200	23,2	23,4	25,2	4,73	69,41	328,1	X
31.13.070205	MEAT	350	23,2	23,4	25,2	8,28	71,27	590,4	X
31.13.070205	MEAT	500	23,2	23,4	25,2	11,75	65,58	770,4	X
31.13.070207	MEAT M	200	23,2	23,4	25,2	4,73	66,77	315,6	X
31.13.070207	MEAT M	350	23,2	23,4	25,2	8,28	69,25	573,6	X
31.13.070207	MEAT M	500	23,2	23,4	25,2	11,75	64,36	756	X
31.13.070209	VEGET	200	23,2	23,4	25,2	4,73	89,26	421,92	X
31.13.070209	VEGET	350	23,2	23,4	25,2	8,28	97,78	810	X
31.13.070209	VEGET	500	23,2	23,4	25,2	11,75	90,61	1064,4	X

Note: It is required to keep Tc < 65°C.

Tolerance range for flux measurements of 8%.

For module supply including high adhesion thermal tape, please add the letter "C" behind the product code. Example: 31.13.07023C.

QTY LED 24 CRI TYP >90

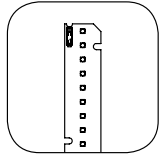

CONNECTION EXAMPLE

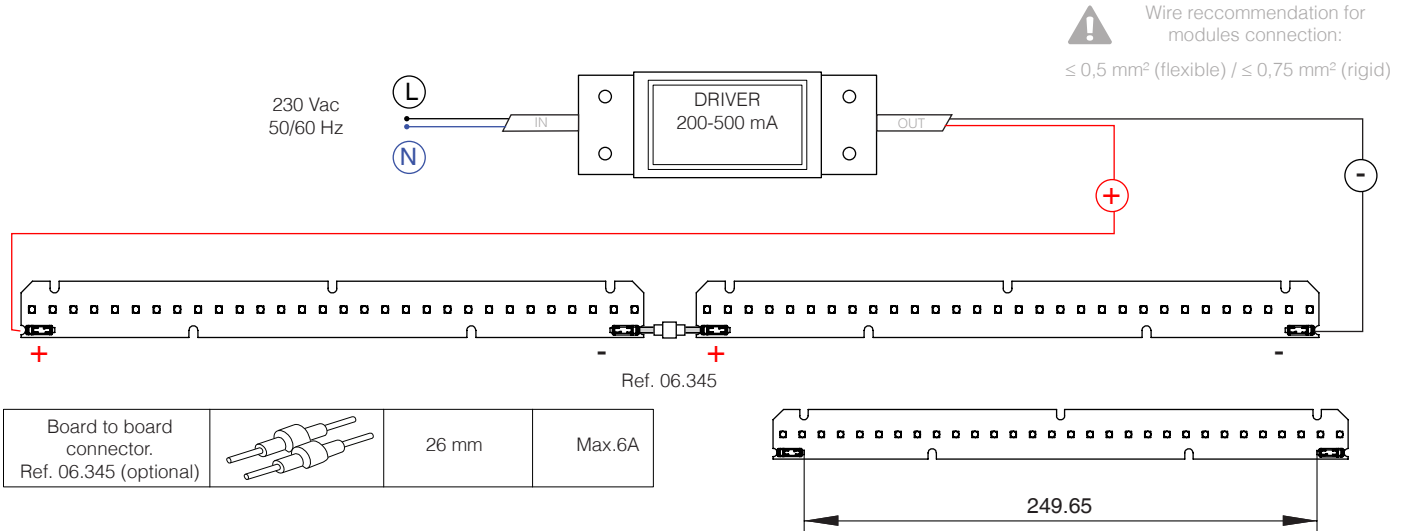

SPECTRUM POWER DISTRIBUTION

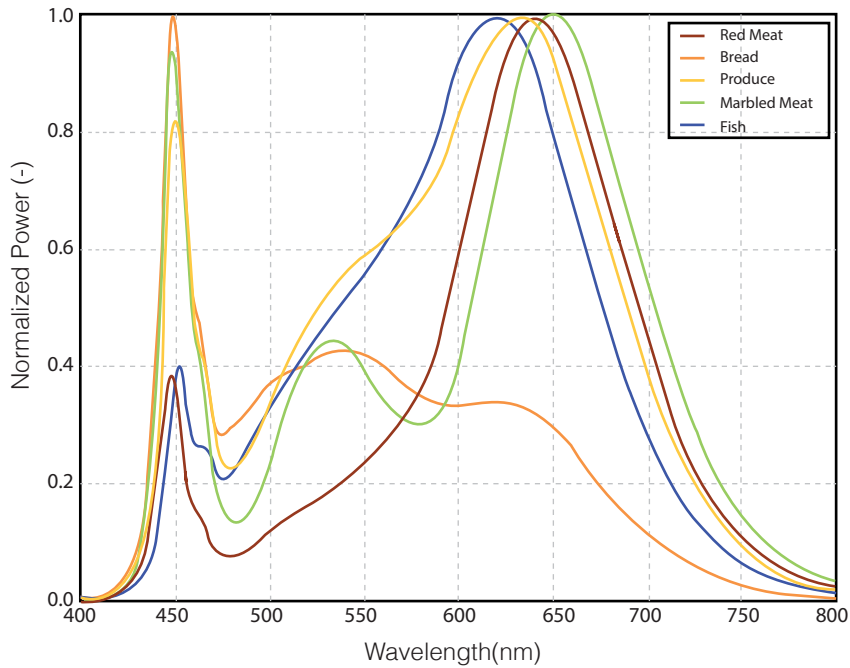

3SDCM DEFINICIÓN ELIPSE - CENTER POINT

	Center Point		Rotation Elip.
	(CX)	(CY)	
Vegetables	0,421	0,372	53,2°
Red Meat	0,5	0,35	49,3°
Marbled Meat	0,395	0,325	53,7°
Fish	0,313	0,323	58,6°
Bread	0,4578	0,4101	53,7°w

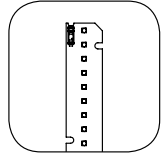

INSTALLATION AND CONNECTION EXAMPLE

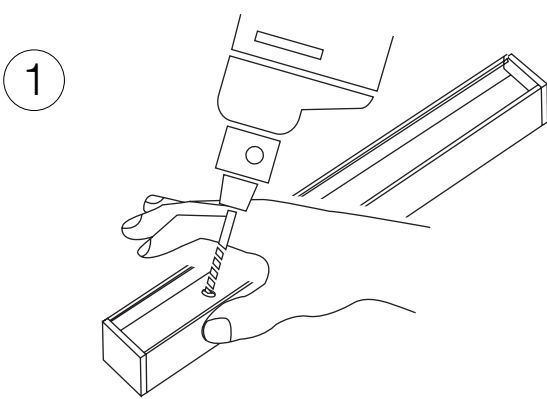

1 For eventual attachment of the fixture (with no use of double sided adhesive tape) drill a hole in the profile.

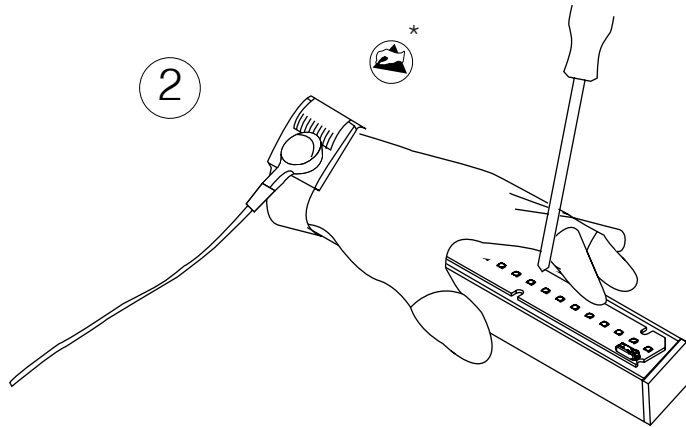

2 Place the PCB and apply pressure. Fix the screws to the fixture base. Note: Accessory M3 screws.

(*) ESD protection.

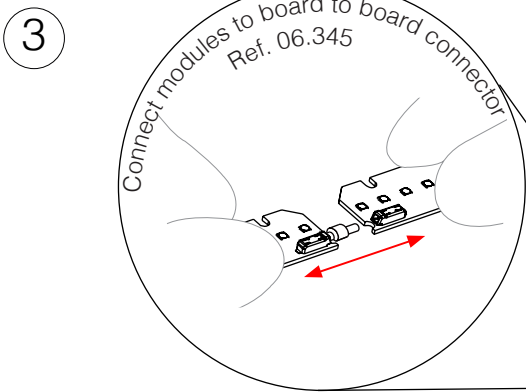

3 Connect modules to board to board connector
Ref. 06.345



Max. Nº of de módulos:
Depende del Driver a utilizar
 $V_f \text{ total PCBs} \leq V_{out} \text{ Driver}$

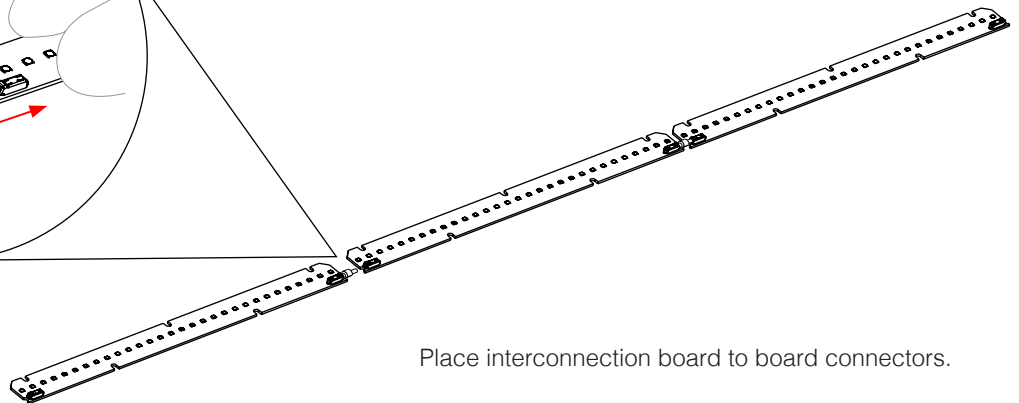

Place interconnection board to board connectors.

Lifetime Derating for MERAKI LINEAL MERAKI 282 ECO

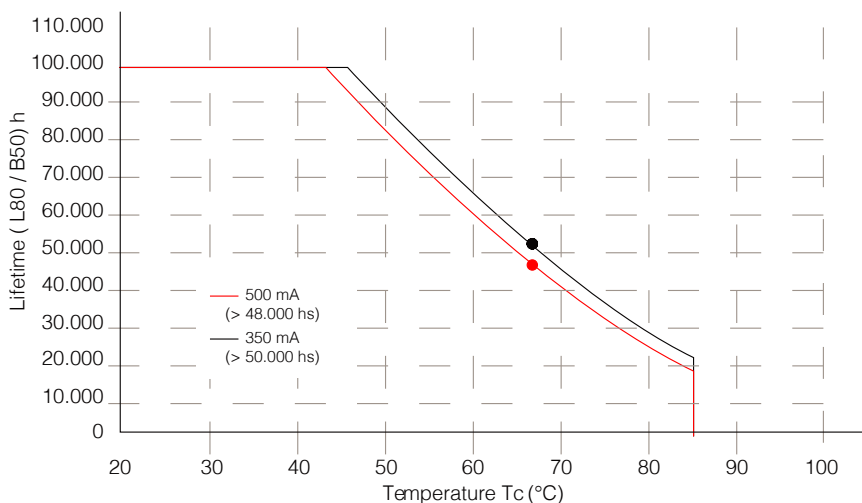

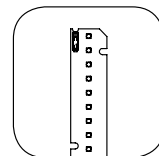

INFORMACIÓN DE SEGURIDAD E INSTALACIÓN



ELECTRICAL POWER

MERAKI ECO 282 FOODY must be feed at constant current; the energy source power must be in accordance with the quantity of connected modules for proper functioning of the module (or group of modules). Family MERAKI LED MODULES have polarity, for this reason rated current, nominal power and polarity must be taken into account. If that is not the case, the module might be irreversibly damaged. MERAKI LED MODULES require specific driver protection against short-circuit currents, temperature raise and overloads.



ISOLATION

MERAKI ECO 282 FOODY functions with SELV voltage, does not require active isolation of the component as long as maximum reference SELV voltage is not exceeded. In other case, it will be mandatory earth connection on all conductive components of the fixture or light engine when the number of modules in the series exceeds SELV voltage. The driver must be in compliance with CE, UL or valid analogous regulation.



ESD – STATIC ELECTRICITY INFORMATION

MERAKI ECO 282 FOODY contains electronic components which are very sensible to static electricity. In this respect is it highly recommendable to always manipulate the items with appropriate ESD protection, and take adequate measures for safety matters. If you need further information please refer to our webpage www.idled.eu.



MOUNTING AND INSTALLATION

I+D LED S.L. is not responsible for the installation of the product. MERAKI ECO 282 FOODY must be perfectly placed (and/or stick) on the lighting device, profile or base for a proper connection between modules and power source. Thermal transference between PCB and luminaire body must be at its highest, in order to ensure that fixture temperature does not exceed T_c in any case.

If any type of chemical substance is used during the assembly of the luminaire or light engine, it must not have any type of curing by means of gas condensation; as these chemical substances may damage the LEDs.

The module will be delivered with pre-made holes of $D=4$ mm according to dimensions drawing (ZHAGA L70W2).

Maximum torque for fixing recommended 0,4-0,5 Nm to avoid mechanical stress. Ideal wire for this connection type is unipolar rigid wire of 0,4-1mm², with a strip wire of 6,5-7MM. To remove wire, push orifice on the connector and pull smoothly.



TEMPERATURE

MERAKI ECO 282 FOODY life-time depends to a great extent on operating temperature. Under no circumstance temperature should exceed the maximum permissible ($T_c=65^{\circ}\text{C}$) limit here indicated. Exposure to higher temperatures might affect its long term proper functioning. Room temperature must be measured under worst-case conditions to ensure life-time and keep product's guarantee. Store modules between -20°C and $+80^{\circ}\text{C}$, and at a maximum humidity level of 65%.



OPTICAL CHARACTERISTICS + CCT

Measurement of LED discrete points may have variations in regards on the CCT temperature here described, with a variance of 3SDCM for white and $\pm 5\text{nm}$ for coloured LEDs. CCT shifts $\pm 0,001$ at 6.000 hrs. 3 SDCM are declared over the complete module. Modules viewing angle is 120° .